



I-SYS



European Organisation for Technical Approvals

Deutsches Institut für Bautechnik

Anstalt des öffentlichen Rechts

Kolonnenstr. 30 L
10829 Berlin
Germany

Tel.: +49(0)30 787 30 0
Fax: +49(0)30 787 30 320
E-mail: dibt@dibt.de
Internet: www.dibt.de

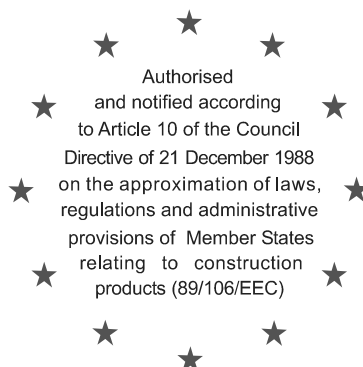

DIBt

Mitglied der EOTA
Member of EOTA

European Technical Approval ETA-10/0358

English translation prepared by DIBt - Original version in German language

Handelsbezeichnung
Trade name

Carl Stahl Seil-Zugglieder I-SYS
Carl Stahl Wire Ropes I-SYS

Zulassungsinhaber
Holder of approval

Carl Stahl GmbH
Postweg 41
73079 Süssen
DEUTSCHLAND

Zulassungsgegenstand
und Verwendungszweck
*Generic type and use
of construction product*

Vorgefertigte Seile aus nichtrostendem Stahl mit
Endverankerungen
Prefabricated stainless steel wire ropes with end connectors

Geltungsdauer: vom
Validity: from
bis
to

27 October 2010
27 October 2015

Herstellwerk
Manufacturing plant

Carl Stahl GmbH
Postweg 41
73079 Süssen
DEUTSCHLAND

Diese Zulassung umfasst
This Approval contains

14 Seiten einschließlich 7 Anhänge
14 pages including 7 annexes



Europäische Organisation für Technische Zulassungen
European Organisation for Technical Approvals

I LEGAL BASES AND GENERAL CONDITIONS

- 1 This European technical approval is issued by Deutsches Institut für Bautechnik in accordance with:
 - Council Directive 89/106/EEC of 21 December 1988 on the approximation of laws, regulations and administrative provisions of Member States relating to construction products¹, modified by Council Directive 93/68/EEC² and Regulation (EC) N° 1882/2003 of the European Parliament and of the Council³;
 - Gesetz über das In-Verkehr-Bringen von und den freien Warenverkehr mit Bauprodukten zur Umsetzung der Richtlinie 89/106/EWG des Rates vom 21. Dezember 1988 zur Angleichung der Rechts- und Verwaltungsvorschriften der Mitgliedstaaten über Bauprodukte und anderer Rechtsakte der Europäischen Gemeinschaften (Bauproduktengesetz - BauPG) vom 28. April 1998⁴, as amended by law of 31 October 2006⁵;
 - Common Procedural Rules for Requesting, Preparing and the Granting of European technical approvals set out in the Annex to Commission Decision 94/23/EC⁶.
- 2 Deutsches Institut für Bautechnik is authorized to check whether the provisions of this European technical approval are met. Checking may take place in the manufacturing plant. Nevertheless, the responsibility for the conformity of the products to the European technical approval and for their fitness for the intended use remains with the holder of the European technical approval.
- 3 This European technical approval is not to be transferred to manufacturers or agents of manufacturers other than those indicated on page 1, or manufacturing plants other than those indicated on page 1 of this European technical approval.
- 4 This European technical approval may be withdrawn by Deutsches Institut für Bautechnik, in particular pursuant to information by the Commission according to Article 5(1) of Council Directive 89/106/EEC.
- 5 Reproduction of this European technical approval including transmission by electronic means shall be in full. However, partial reproduction can be made with the written consent of Deutsches Institut für Bautechnik. In this case partial reproduction has to be designated as such. Texts and drawings of advertising brochures shall not contradict or misuse the European technical approval.
- 6 The European technical approval is issued by the approval body in its official language. This version corresponds fully to the version circulated within EOTA. Translations into other languages have to be designated as such.

1 Official Journal of the European Communities L 40, 11 February 1989, p. 12
2 Official Journal of the European Communities L 220, 30 August 1993, p. 1
3 Official Journal of the European Union L 284, 31 October 2003, p. 25
4 *Bundesgesetzblatt Teil I 1998*, p. 812
5 *Bundesgesetzblatt Teil I 2006*, p. 2407, 2416
6 Official Journal of the European Communities L 17, 20 January 1994, p. 34

II SPECIFIC CONDITIONS OF THE EUROPEAN TECHNICAL APPROVAL

1 Definition of the product and intended use

1.1 Definition of the construction product

The construction products are prefabricated high-strength stainless steel wire ropes with appropriate end connectors and the trade name "Carl Stahl Wire Ropes I-SYS".

Drawings of the wire ropes with end connectors as well as their essential dimensions are given in the Annexes to this European technical approval.

1.2 Intended use

The intended use comprises all typical structural applications of stainless steel wire ropes taking into account the national provisions of the Member State applicable for the location where the product is incorporated in the works.

The wire ropes with end connectors are intended for the use in structures with predominantly static loads only.

The installed wire ropes with end connectors shall be accessible (in order) to facilitate replacement of individual components at any time.

The provisions made in this European technical approval are based on an assumed working life of the prefabricated stainless steel wire ropes with end connectors of 25 years. The indications given on the working life cannot be interpreted as a guarantee given by the producer, but are to be regarded only as a means for choosing the right products in relation to the expected economically reasonable working life of the works.

2 Characteristics of product and methods of verification

2.1 Characteristics of the product

2.1.1 Wire ropes

The wire ropes mentioned in section 1 shall correspond to EN 10264-4:2002 as well as to the series of the standards EN 12385. In addition the indications in section 2.1.2 as well as Annexes 2 to 7 shall be taken into account.

2.1.2 End connectors (Fork end connectors and threaded end connectors, turnbuckles)

For the product characteristics of the end connectors the indications in Annex 3 apply.

The dimensions shall correspond to the indications in Annexes 4 to 7. The threads shown in Annexes 4, 6 and 7 are metric ISO threads M 10 to M 36. The dimensions and tolerances not indicated in Annexes 4 to 7 shall correspond to the indications laid down in the technical documentation⁷ to this European technical approval.

The end connectors shown in Annexes 4 to 7 may be used for open spiral strands according to the indications given in Annexes 2 to 7.

2.1.3 Pins for fork end connectors

The indications given in Annexes 3, 5 and 7 apply.

⁷ The technical documentation to this European technical approval is deposited with Deutsches Institut für Bautechnik and, as far as relevant for the tasks of the approved bodies involved in the attestation of conformity procedure is handed over to the approved bodies.

3 Evaluation and attestation of conformity and CE marking

3.1 System of attestation of conformity

According to the communication of the European Commission⁹ system 2+ of the attestation of conformity applies.

This system of attestation of conformity is defined as follows:

System 2+: Declaration of conformity of the product by the manufacturer on the basis of:

(a) Tasks for the manufacturer:

- (1) initial type-testing of the product;
- (2) factory production control;
- (3) testing of samples taken at the factory in accordance with a prescribed test plan.

(b) Tasks for the approved body:

- (4) certification of factory production control on the basis of:
 - initial inspection of factory and of factory production control;
 - continuous surveillance, assessment and approval of factory production control.

Note: Approved bodies are also referred to as "notified bodies".

3.2 Responsibilities

3.2.1 Tasks for the manufacturer

3.2.1.1 Factory production control

The manufacturer shall exercise permanent internal control of production. All the elements, requirements and provisions adopted by the manufacturer shall be documented in a systematic manner in the form of written policies and procedures, including records of results performed. This production control system shall insure that the product is in conformity with this European technical approval.

The manufacturer may only use initial materials stated in the technical documentation of this European technical approval.

The factory production control shall be in accordance with the control plan of 27.10.2010 relating to the European technical approval ETA-10/0358 issued on 27.10.2010 which is part of the technical documentation of this European technical approval. The control plan is laid down in the context of the factory production control system operated by the manufacturer and deposited with Deutsches Institut für Bautechnik.¹⁰

The results of factory production control shall be recorded and evaluated in accordance with the provisions of the control plan.

3.2.1.2 Other tasks for the manufacturer

The manufacturer shall, on the basis of a contract, involve a body which is approved for the tasks referred to in section 3.1 in the field of "Prefabricated wire ropes with end connectors" in order to undertake the actions laid down in section 3.2.2. For this purpose, the control plan referred to in sections 3.2.1.1 and 3.2.2 shall be handed over by the manufacturer to the approved body involved.

The manufacturer shall make a declaration of conformity, stating that the construction product is in conformity with the provisions of the European technical approval ETA-10/0358 issued on 27.10.2010.

⁹ Letter of the European Commission of 16/01/2009 to EOTA

¹⁰ The "control plan" is a confidential part of the European technical approval and only handed over to the approved body involved in the procedure of attestation of conformity. See section 3.2.2.

3.2.2 Tasks for the approved bodies

The approved body shall perform the

- initial inspection of factory and of factory production control,
- continuous surveillance, assessment and approval of factory production control

in accordance with the provisions laid down in the control plan.

The approved body shall retain the essential points of its actions referred to above and state the results obtained and conclusions drawn in a written report.

The approved certification body involved by the manufacturer shall issue an EC certificate of conformity of the factory production control stating the conformity with the provisions of this European technical approval.

In cases where the provisions of the European technical approval and its control plan are no longer fulfilled the certification body shall withdraw the certificate of conformity and inform Deutsches Institut für Bautechnik without delay.

3.3 CE marking

The CE marking shall be affixed on each packaging of the wire ropes with end connectors. The letters "CE" shall be followed by the identification number of the approved certification body, where relevant, and be accompanied by the following additional information:

- the name and address of the producer (legal entity responsible for the manufacture),
- the last two digits of the year in which the CE marking was affixed,
- the number of the EC certificate for the factory production control,
- the number of the European technical approval,
- the type or name of the product.

4 Assumptions under which the fitness of the product for the intended use was favourably assessed

4.1 Manufacturing

The European technical approval is issued for the product on the basis of agreed data/information, deposited with Deutsches Institut für Bautechnik, which identifies the product that has been assessed and judged. Changes to the product or production process, which could result in this deposited data/information being incorrect, should be notified to Deutsches Institut für Bautechnik before the changes are introduced. Deutsches Institut für Bautechnik will decide whether or not such changes affect the approval and consequently the validity of the CE marking on the basis of the approval and if so whether further assessment or alterations to the approval shall be necessary.

4.2 Installation

The installation is carried out such that the wire ropes with end connectors are accessible for repair or maintenance at any time.

The installation is only carried out according to the manufacturer's instructions. The manufacturer hands over the assembly instructions to the assembler. From the assembly instructions it is followed that, prior to installation, all components of the wire ropes with end connectors shall be checked for their perfect condition and that damaged components shall not be used.

By using end connectors consisting of threaded end connector, turnbuckle and fork end connector with thread (see Annex 1) the threaded end connectors as well as the fork end connectors with thread are screwed in to the turnbuckles with a minimum thread engagement corresponding to the dimension "c" according to Annex 6.

The responsible assembler attests by notation that all connections with threads were checked concerning the keeping of the minimum thread engagements.

The conformity of the gusset plates and the installed wire ropes with end connectors with the provisions of the European technical approval is attested by the executing assembler.

4.3 Design

The design is carried out according to EN 1993-1-11:2006⁸.

The design values of resistance given in section 2.1.4 are used for design.

The loading is predominantly static.

The dimensions, tolerances, material properties and thread engagements stated in this European technical approval are observed.

The design is carried out by a designer of the structure experienced in the field of steel structures.

5 Indications to the manufacturer

The manufacturer shall ensure that the information on the specific conditions according to sections 1, 2, 4.2 and 4.3 (including Annexes referred to) is given to those who are concerned. This information may be given by reproduction of the European technical approval.

In addition all essential installation data shall be shown clearly on the package or on an enclosed instruction sheet, preferably using illustration(s).

The wire ropes with end connectors shall be packaged and delivered as a complete unit only.

Georg Feistel
Head of Department

beglaubigt:
Spohn

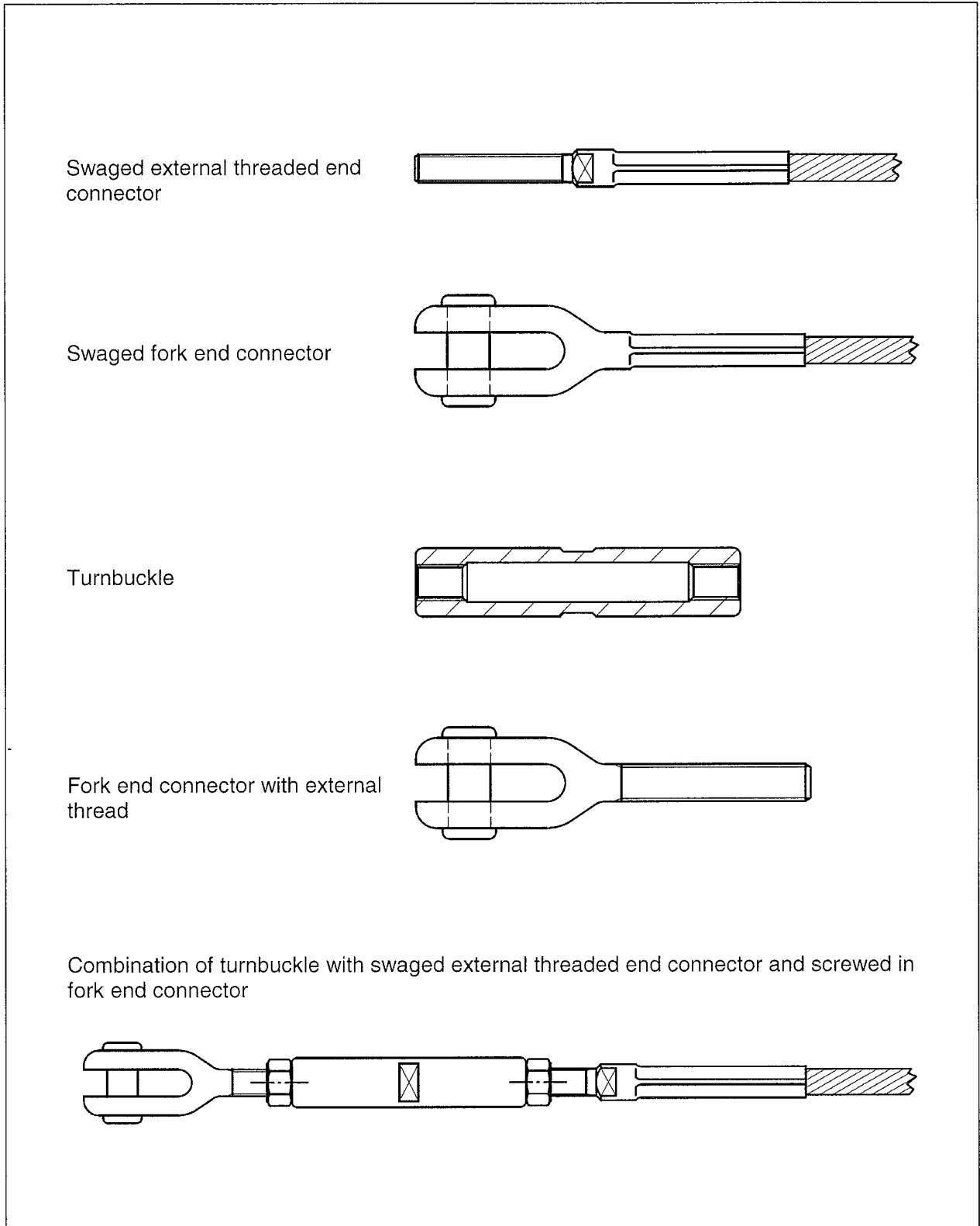

<p>Carl Stahl Wire Ropes I-SYS System, components</p>	<p>Annex 1</p>
<p>Carl Stahl GmbH Postweg 41 D-73079 Süssen architektur@carlstahl.com</p>	<p>to European Technical Approval</p> <p>ETA-10/0358</p>



Table 1: Combinations

End connector	Open spiral strand		
	Strand 1 x 19 Rope Ø [mm]	Strand 1 x 37 Rope Ø [mm]	Strand 1 x 61 Rope Ø [mm]
Swaged external threaded end connector	6, 8, 10, 12, 14	16, 18	22, 26
Swaged fork end connector	6, 8, 10, 12, 14	16, 18	22, 26
Combination according to Annex 1	6, 8, 10, 12, 14	16, 18	22, 26

Table 2: Loss factor k_s ,
 Modulus of elasticity E_Q according to EN 1993-1-11:2006,
 Metallic cross section A_m

Type of strand	Structure of strand	Rope Ø [mm]	k_s [-]	E_Q [N/mm ²]	A_m [mm ²]
Open spiral strands	1 x 19	6	0.88	130	21.49
	1 x 19	8	0.88	130	38.20
	1 x 19	10	0.88	130	59.69
	1 x 19	12	0.88	130	85.95
	1 x 19	14	0.88	130	116.99
	1 x 37	16	0.87	130	150.80
	1 x 37	18	0.87	130	190.80
	1 x 61	22	0.87	130	285.10
	1 x 61	26	0.87	130	398.20

Table 3: Strand factor k_e depending on wire tensile strength R_m

Rope Ø [mm]	6 - 10	12 - 14	16 - 18			22 - 26
Structure of strand	1 x 19		1 x 37			1 x 61
R_m [N/mm ²]	1570	1570	1370	1450	1500	1450
k_e [-]	0.9	0.82	0.90	0.88	0.86	0.78

Carl Stahl Wire Ropes I-SYS
 Characteristics of product

Carl Stahl GmbH
 Postweg 41
 D-73079 Süssen
 architektur@carlstahl.com



Annex 2

to European
 Technical Approval

ETA-10/0358

Table 4: Mechanical properties of components after cold work hardening (min. values),
 Coefficient of thermal expansion

Components	Material-no.:	Mechanical properties ¹⁾		Coefficient of thermal expansion
		R _{p0,2} [N/mm ²]	R _m [N/mm ²]	α _T [K ⁻¹]
Wire of rope 1x19	1.4401	-	1570	16x10 ⁻⁶
Wire of rope 1x37	1.4401	-	1370-1500	16x10 ⁻⁶
Wire of rope 1x61	1.4401	-	1450	16x10 ⁻⁶
Swaged external threaded end connector	1.4401	210	500	16x10 ⁻⁶
Swaged fork end connector (incl. pin)	1.4401	210	500	16x10 ⁻⁶
Fork end connector with external thread (incl. pin)	1.4401	210	500	16x10 ⁻⁶
Turnbuckle	1.4401	210	500	16x10 ⁻⁶

¹⁾ quod vide EN 10264-4:2002

Carl Stahl Wire Ropes I-SYS
 Characteristics of product

Carl Stahl GmbH
 Postweg 41
 D-73079 Süssen
 architektur@carlstahl.com



Annex 3

to European
 Technical Approval

ETA-10/0358

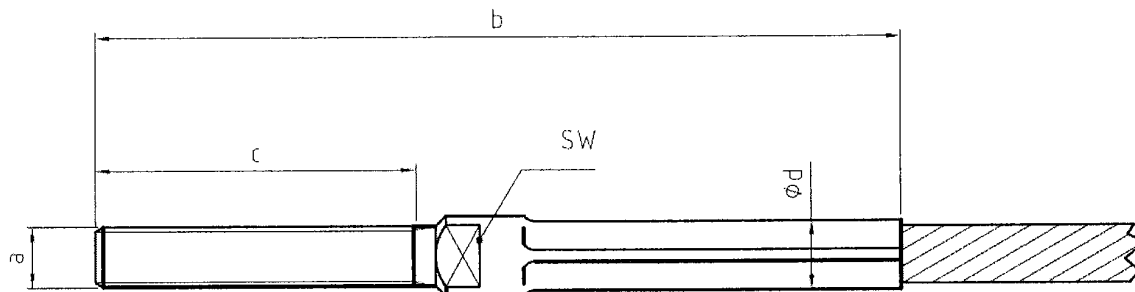

Swaged external threaded end connector					
Rope Ø [mm]	Thread size a	b [mm]	c [mm]	Ød [mm]	SW [mm]
6	M10	117	45	11.11	10
8	M12	156	60	14.03	12
10	M14	193	76	15.75	14
12	M16	232	90	19.03	17
14	M20	259	110	22.24	20
16	M24	313	130	25.25	24
18	M27	357	140	30.46	27
22	M30	430	170	36.40	30
26	M36	475	170	41.18	36

Carl Stahl Wire Ropes I-SYS
 Swaged external threaded end connector

Carl Stahl GmbH
 Postweg 41
 D-73079 Süssen
 architektur@carlstahl.com



Annex 4

to European
 Technical Approval

ETA-10/0358

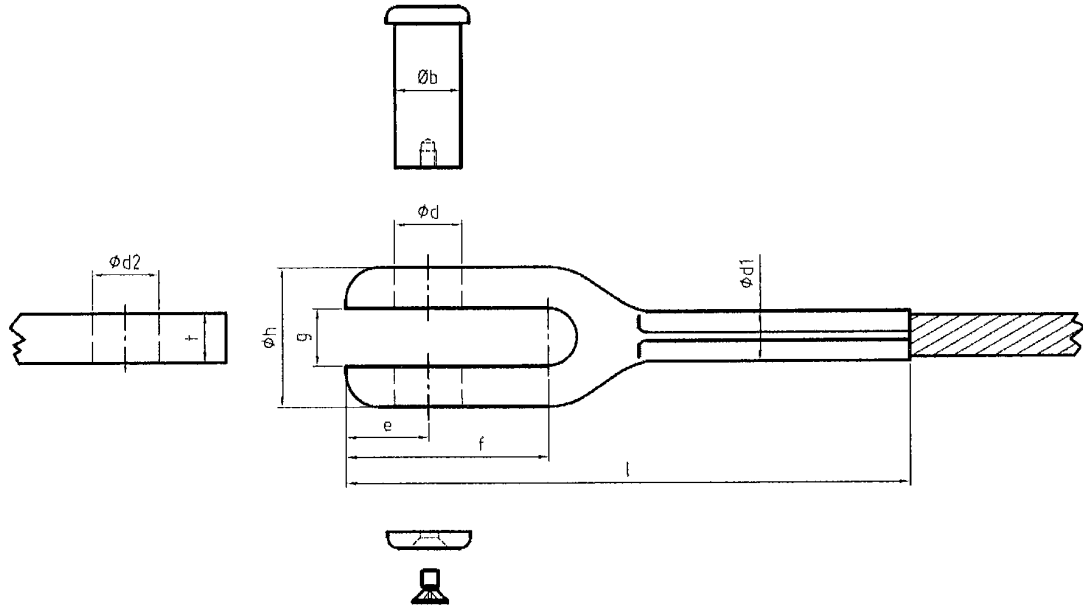

Swaged fork end connector incl. pin									Gusset plate	
Rope Ø [mm]	l [mm]	Øh [mm]	g [mm]	e [mm]	f [mm]	Ød [mm]	Ød1 [mm]	Øb [mm]	Ød2 [mm]	t [mm]
6	116	22	10	14	32	10	11.07	9.9	10	8
8	151	28	12	16	40	12	14.03	11.9	12	10
10	185	34	14	20	49	16	15.70	15.9	16	12
12	220	41	17	25	60	20	18.88	19.9	20	15
14	238	48	20	28	69	23	22.24	22.9	23	18
16	286	54.5	22	33	81	26	25.20	25.9	26	20
18	335	69.5	28	38	91	29	30.46	28.9	29	25
22	379	72	30	40	101	33	36.48	32.9	33	25
26	445	83	33	45	116	36	41.18	35.9	36	30

Carl Stahl Wire Ropes I-SYS
 Swaged fork end connector, pin, gusset plate

Carl Stahl GmbH
 Postweg 41
 D-73079 Süssen
 architektur@carlstahl.com



Annex 5

to European
 Technical Approval

ETA-10/0358

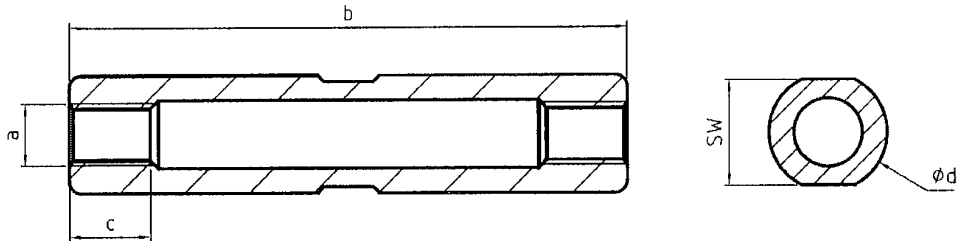

The thread engagement of threaded and fork end connectors according to Annexes 4 and 7 should be at least the dimension "c" according to this Annex.

Turnbuckle				
Thread size a	b [mm]	c [mm]	Ød [mm]	SW [mm]
M10	90	13	19	17
M12	104	15	20	18
M14	136	17	25	22
M16	158	20	28	24
M20	196	23	32	28
M24	230	26	40	36
M27	244	30	48	41
M30	302	35	54	46
M36	302	40	60	55

Carl Stahl Wire Ropes I-SYS
 Turnbuckle

Carl Stahl GmbH
 Postweg 41
 D-73079 Süssen
 architektur@carlstahl.com



Annex 6

to European
 Technical Approval

ETA-10/0358

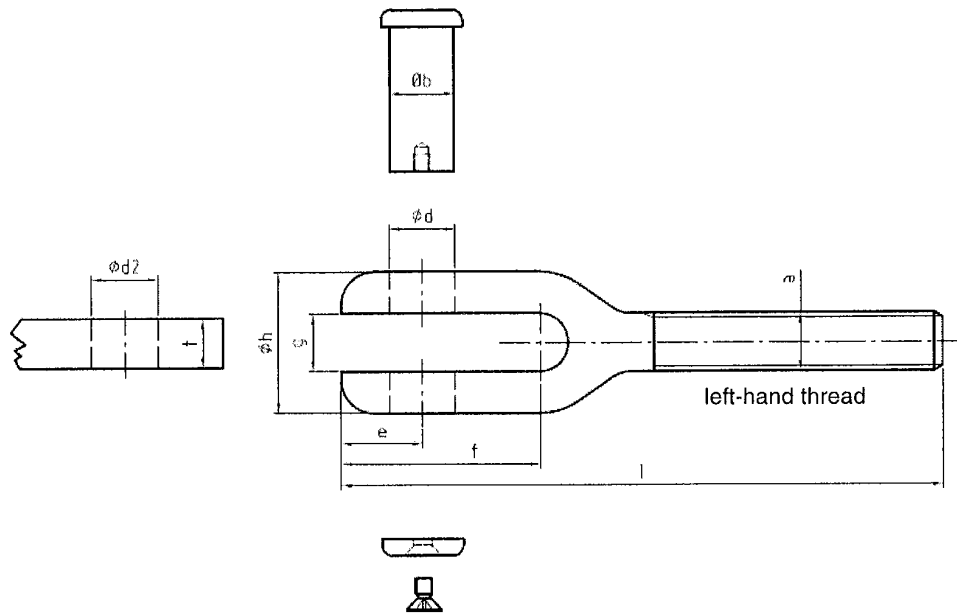

Fork end connector with external thread incl. pin									Gusset plate	
Rope Ø [mm]	Thread size a	l [mm]	Øh [mm]	g [mm]	e [mm]	f [mm]	Ød [mm]	Øb [mm]	Ød2 [mm]	t [mm]
6	M10	93	22	10	14	32	10	9.9	10	8
8	M12	121	28	12	16	40	12	11.9	12	10
10	M14	148	34	14	20	49	16	15.9	16	12
12	M16	180	41	17	25	60	20	19.9	20	15
14	M20	214	48	20	28	69	23	22.9	23	18
16	M24	260	54,5	22	33	81	26	25.9	26	20
18	M27	284	69,5	28	38	91	29	28.9	29	25
22	M30	322	72	30	40	101	33	32.9	33	25
26	M36	346	83	33	45	116	36	35.9	36	30

Carl Stahl Wire Ropes I-SYS
 Fork end connector with external thread, pin, gusset plate

Carl Stahl GmbH
 Postweg 41
 D-73079 Süssen
 architektur@carlstahl.com



Annex 7
 to European
 Technical Approval
ETA-10/0358



Carl Stahl GmbH · Postweg 41 · 73079 Süßen · Tel.: (0 71 62) 4007-2100 · Fax: (0 71 62) 4007-8821
Email: architektur@carlstahl.com · Internet: www.carlstahl-architektur.de